

LTR	MODIFICATION	DATE	REFERENCE	APPLY GEN. TO BRANCE TO UNSPECIFIED TOR BRANCES.
			0 TO 6	6 TO 30
			30 TO 120	120 TO 315
			315 TO 503	503 TO 800
			800 TO 1120	1120 TO 1720

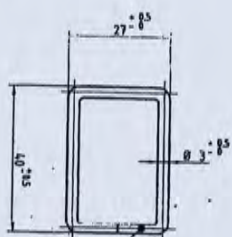
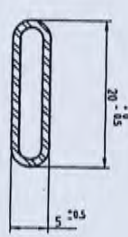
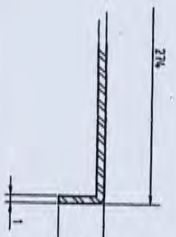
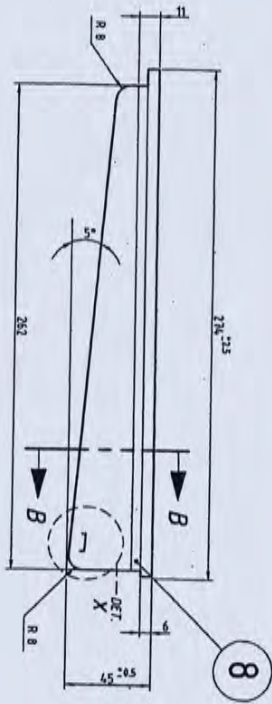
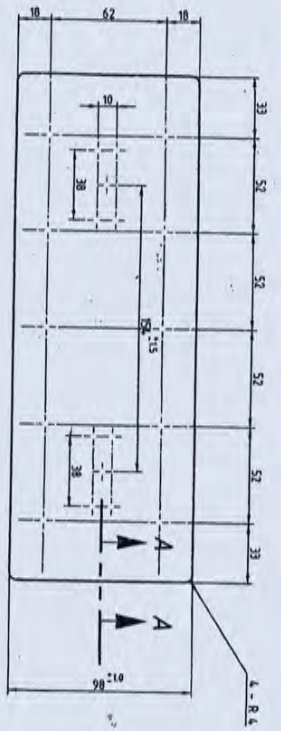

SECTION A - A

SECTION C - C

SECTION D - D

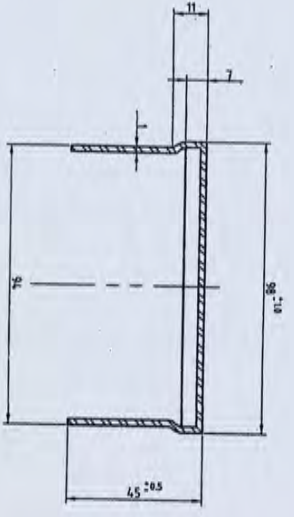

SECTION B - B

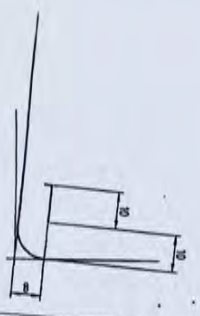

DETAIL X

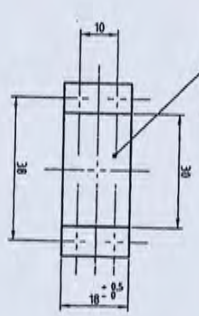
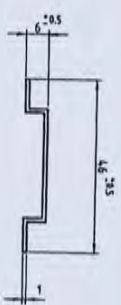

NO	DESCRIPTION	QTY	MATERIAL / HARDNESS
1	COVER HANDLE	10 THK	TIN FREE STEEL
2	HANDLE HOLDER	Ø 3	COLD DRAWN STEEL WIRE
2	COVER HANDLE CLIP	10 THK	TIN FREE STEEL
1	TOP COVER PLATE	10 THK	TIN FREE STEEL
PART NO. 8			
MATERIAL / HARDNESS			

DESIGNED	DATE	21 JUL 63
CHECKED	DATE	21 JUL 63
APPROVED BY	DATE	09 APR 64
DIRECTOR	DATE	

TITLE:	DWG No.	Scale:
METAL AMMUNITION BOX FOR 7.62 MM	QMB 04A	1:1
REPUBLIC OF THE PHILIPPINES	INCH	
DEPARTMENT OF NATIONAL DEFENSE		
GOVERNMENT ARSENAL		
Camp General Antonio Luna		
LANAO LAHAY BATAAN		

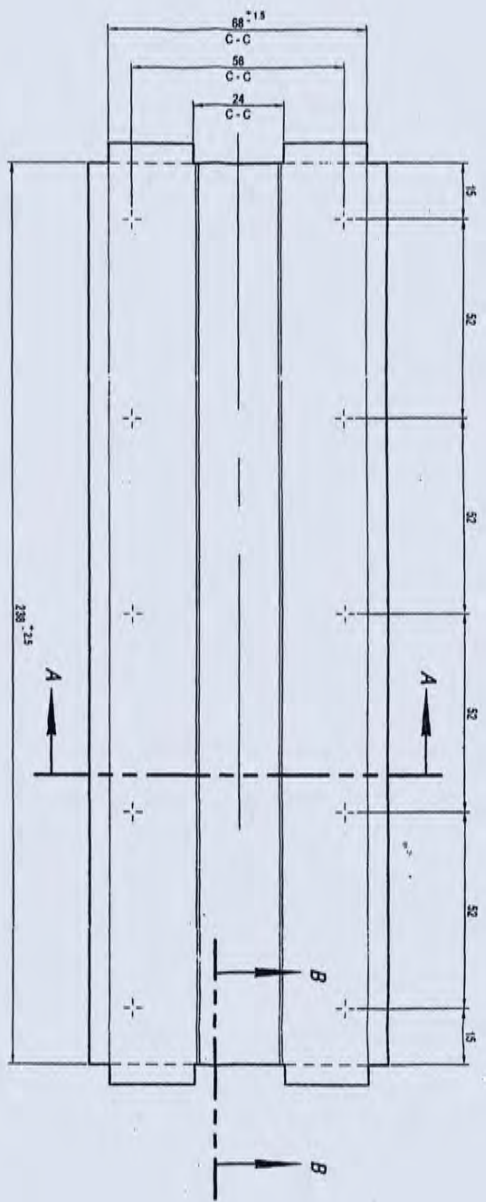

14 GASKET RETAINER PLATE

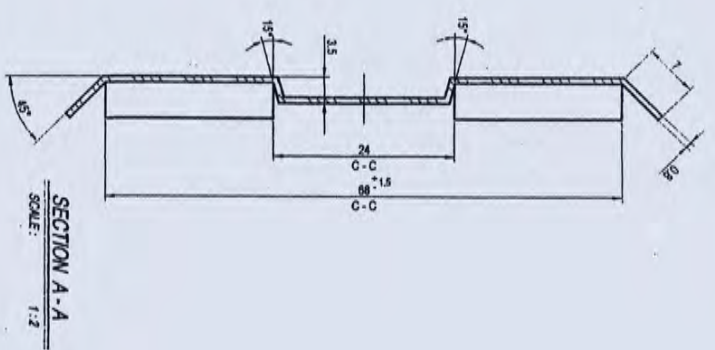

SECTION A-A
SCALE: 1:2

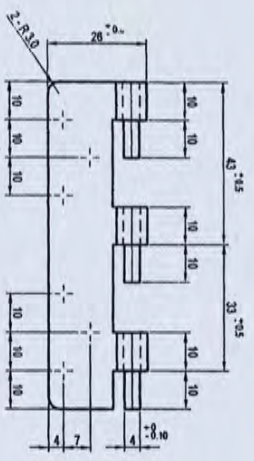

13 BODY HINGE

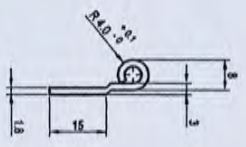

SECTION B-B
SCALE: 1:2

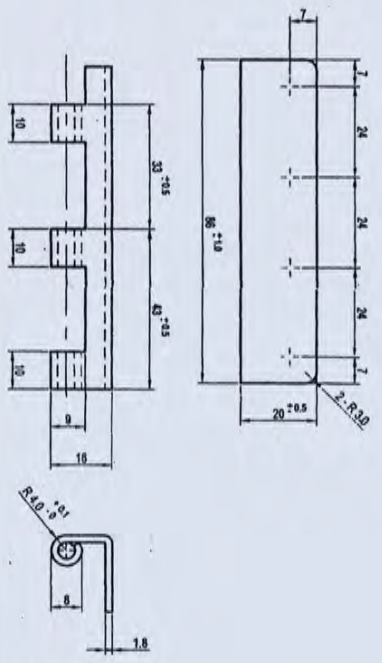

12 COVER HINGE

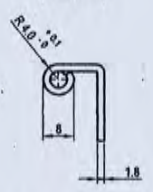

SECTION B-B
SCALE: 1:2

1	GASKET RETAINER PLATE	14	TIN FREE STEEL	0.8 THICK
1	BODY HINGE	13	TIN FREE STEEL	1.8 THICK
1	COVER HINGE	12	TIN FREE STEEL	1.8 THICK
QTY		PART NO.		
DESCRIPTION		MATERIAL		
DRAWN		DATE		
DESIGNED		DATE		
CHECKED		DATE		
RECOMMENDED APPROVAL		DATE		
ENGR. RONALD C. DEAN, ME		DATE		
SPLT. ENGINEERING DIV.		DATE		
APPROVED BY: <i>[Signature]</i>		DATE		
RADM ERIBERTO C. VARGAS, AFP (PMA)		DATE		
TITLE: METAL AMMUNITION BOX FOR 7.62 MM				
Republic of The Philippines Department of National Defense GOVERNMENT ARSENAL Camp General Antonio Luna Linao, Tarlac, Pinaric				
Scale: 1:1		Dwg. No. GMB 405-1		
SUN. 5		OR		

LT#	MODIFICATION	DATE	REFERENCE
			APPLY GEN. TOLERANCE TO UNSPECIFIED TOLERANCES
			0 TO 6 6 TO 30 30 TO 120 120 TO 315 315 TO 1000
			±0.3 ±0.5 ±0.8 ±1.2 ±2.0

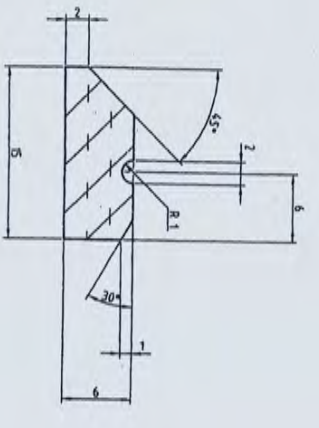
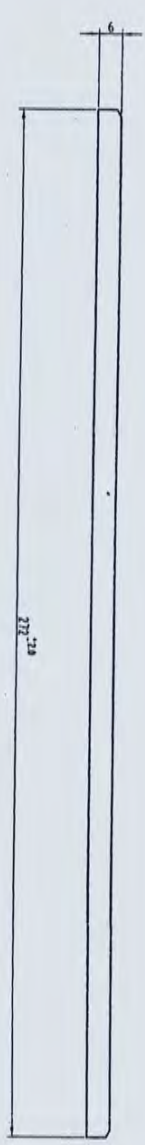
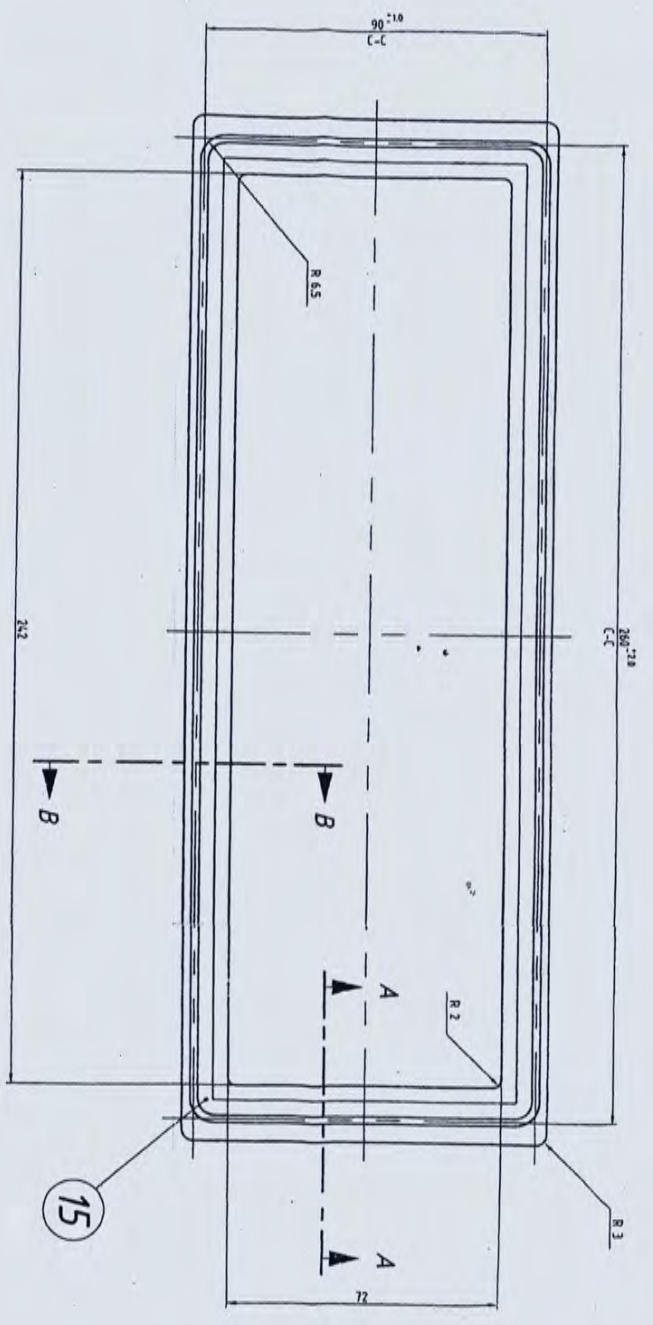

SECTION A - A

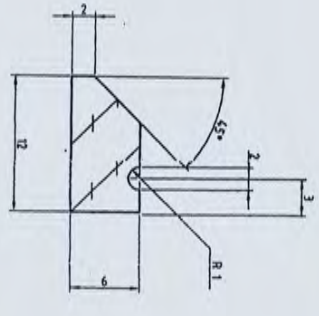

SECTION B - B

NOTES:
 SPECIFIC GRAVITY : 1.2
 HARDNESS (SHORE A) : 50 - 90
 TENSILE STRENGTH : 500 - 3500 PSI
 (3.4 MN/m² TO 24 MN/m²)

QTY	DESCRIPTION	DATE	PART NO.	MATERIAL / HARDNESS
1	RUBBER GASKET		15	NEOPRENE OR HYALON
DRAWN	<i>[Signature]</i>	22 JUL 03		
DESIGNED	<i>[Signature]</i>			
CHECKED	Engr. J. ESPINOSA, CDE			
Recommended Approver	Engr. ROMEO FABIAN	01 04 03		
Approved	Sr. Lt. ENRIQUE B. BAY			
Approved	Plan ENRISTO C. [Signature]			
	DIR. ENRISTO C. [Signature]			
	DIRECTOR			

TITLE : METAL AMMUNITION BOX FOR 7.62 MM

REPUBLIC OF THE PHILIPPINES
 DEPARTMENT OF NATIONAL DEFENSE
 GOVERNMENT ARSENAL
 Camp General Antonio Luna
 LAHAD LIMA - BATAYAN

Scale: 1:1
 Drawing: 1M1
 Dwg. No.: GRB 486
 Sht. No.: 6
 OF 7

LTZ	MODIFICATION	DATE	REFERENCE	APPLY GEN. TOLERANCE TO UNDESIGNED TOLERANCES
				>+10.4
				>+10.50
				>+10.128 TO 315
				>+10.315 TO 1000
				±0.1
				±0.2
				±0.3
				±0.5
				±0.8

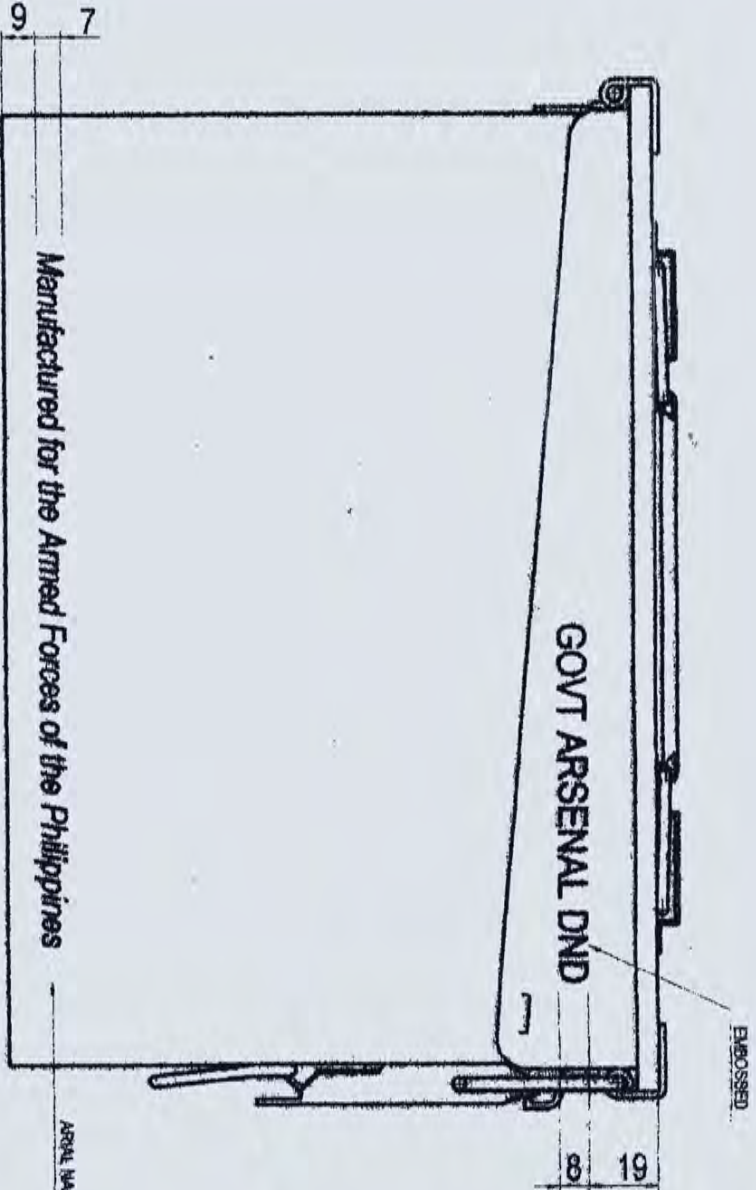

METAL AMMO BOX MARKING

NOTES:
 MARKS SHALL BE LEGIBLE, CLEAR AND WITHOUT ANY SKEW OR ANY PORTION OF LETTER.
 TWO COATINGS OF YELLOW ENAMEL PAINT SHALL BE APPLIED.
 SIZES AND THICKNESS OF MARKINGS SHALL BE AS INDICATED IN THE PLAN.
 THIS DRAWING IS FOR PROCUREMENT PURPOSES ONLY.

DESIGNED	J.C. ONSARANILLA	Date: MARCH 4, 2015	<p>Republic of The Philippines Department of National Defense GOVERNMENT ARSENAL Camp General Antonio Luna Linao, Linao, Bataan</p>	Scale: NTS
CHECKED	EMERSON S. O. DELA ROSA	Date: March 4, '15		Dimension: 1:1
Revised Approved	EMERSON S. O. DELA ROSA	Date: 4 APR 16	TITLE: METAL AMMUNITION BOX FOR GA 762100 / GA 762500 / GA 762405 / GA 556140	Dwg No. MABAG-11
Approved by	JOHN HAN C. MARTIN	Date:		Sheet No. 1

ARMS BARROW - P/ALC

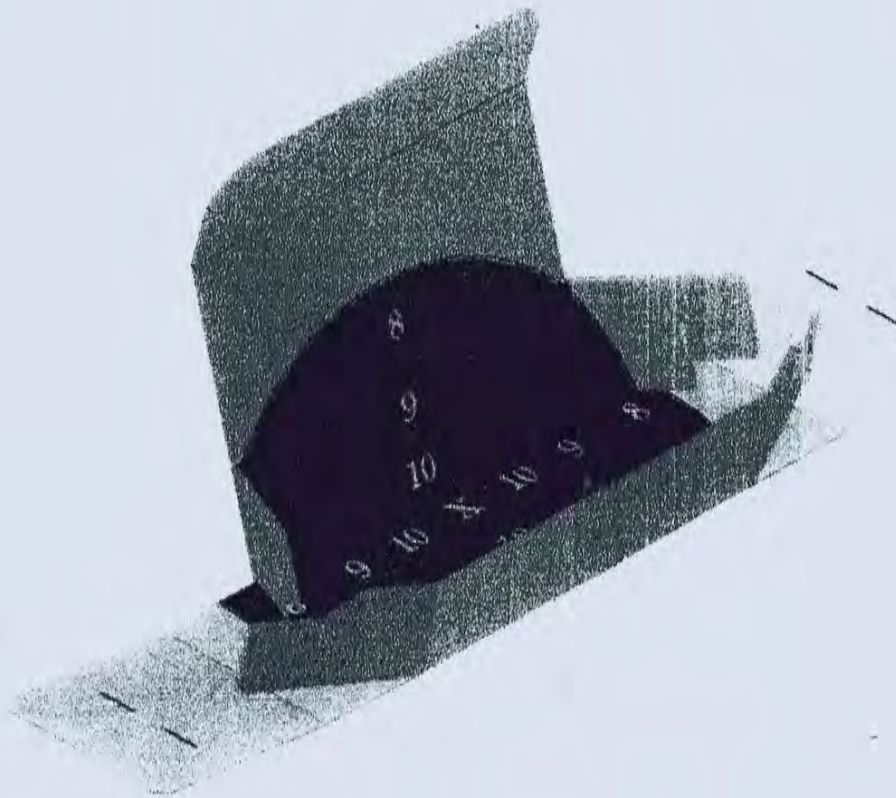
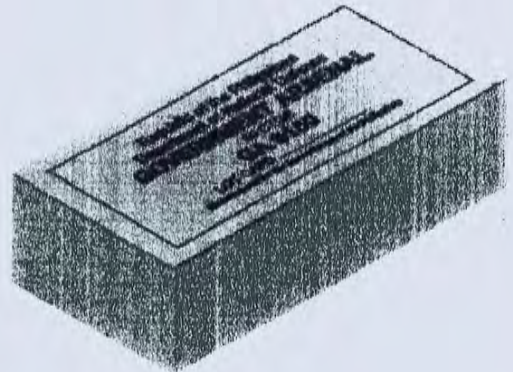
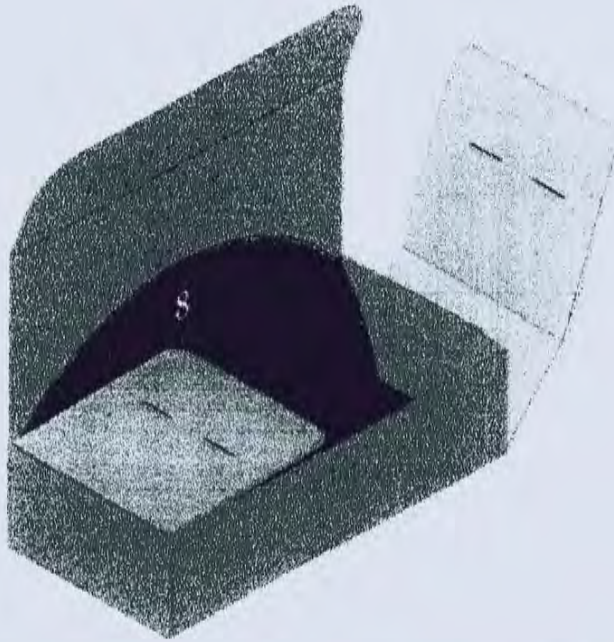

DRAWN  J.C. CABANILLA	Date: MAR. 07, 2017	 Republic Of The Philippines Department of National Defense GOVERNMENT ARSENAL Camp General Antonio Luna Linao, Linao, Bataan	Scale: 1 : 2
DESIGNED	Date:		Dimension: MM
CHECKED  ENGR. S.K.C. PAGUIO	Date:	ASSEMBLY OF CARTON BOX for GA 9100 / GA 9500	Dwg. No. NPCBA-17
Recommend Approval ENGR. CRISOSTOMO M. MARCOS ACTING Supt. ED	Date:		Sht.No. Of
Approved by:  JONATHAN C. MARTIR DIRECTOR	Date:		